







# Cutter RSC 190 PLUS E-FORCE3

Part no.  
**1102151**



# E FORCE 3

-  **FORGED**
-  **360° HANDLE**
-  **CHARGE**
-  **X-CHANGE**
-  **LED LIGHTS**
-  **SPEED CONTROL**

## Technical data:

Opening width	187 mm
Weight (ready to use)	21,9 kg
Dimensions (LxWxH)	920 x 236 x 241 mm
Nominal pressure	700 bar
EN cutting class (EN 13204)	BC187K-21,9
EN cutting performance (EN 13204)	1K-2K-3K-4K-5K
NFPA cutting class (NFPA 1936)	A8-B9-C7-D9-E9-F4

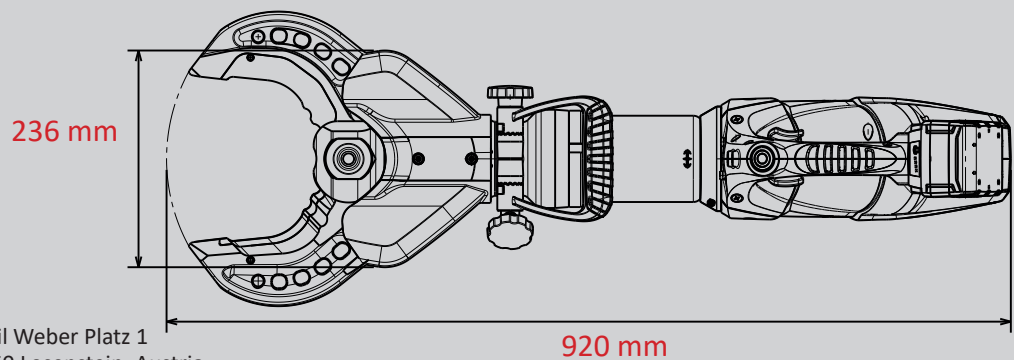
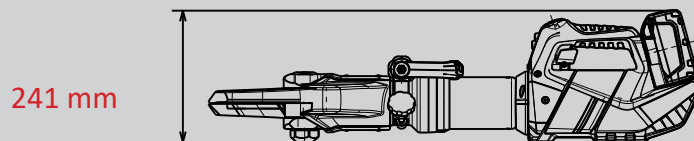

**WEBER-HYDRAULIK GMBH**  
Heilbronner Straße 30  
74363 Güglingen, Germany  
Phone +49 7135 71-10270  
info@weber-rescue.com

Emil Weber Platz 1  
4460 Losenstein, Austria  
Phone +43 7255 6237-120

Images are non-binding. We reserve the right to technical modifications.  
2022A, 05/2022